



Signal Generator SMT

For receiver and EMS measurements
5 kHz to 1.5/3/6 GHz

New: 6 GHz

Signal Generator SMT covers the complete range of conventional analog receiver measurements up to 6 GHz. The SMT affords exceptionally high signal quality for a generator in this price category, as well as outstanding level accuracy, a wide variety of modulation

and signal generation modes, customized configuration, and great ease of operation. Features such as programmable RF, LF and level sweeps as well as the correction of external frequency response make the SMT an ideal source for EMS measurements.

- AM, FM, ϕ M, pulse modulation
- Broadband FM and ϕ M
- Options for signal generation:
 - pulse generator
 - LF generator
 - multifunction generator, eg for stereo and VOR/ILS signals



ROHDE & SCHWARZ

Signal Generator SMT

Types of modulation

- Broadband FM from DC to 8 MHz, deviation up to 40 MHz
- Amplitude modulation
- Phase modulation from DC to 2 MHz

Standard functions

- Convenient RF, LF and level sweeps
- Memory sequence function for automatic measurements
- Programmable level correction for compensation of external frequency response

Innovative operating concept

- Large, backlit LCD for simultaneous display of all relevant settings
- All submenus and current instru-

ment status clearly arranged on the display

- On-line help system, thus no need to consult a manual

LF generator option

- Sinewave signals from 0.1 Hz to 500 kHz
- Triangular and squarewave signals up to 50 kHz
- Noise generator with 500 kHz bandwidth
- Multitone signals in conjunction with standard fixed-frequency generator or second LF generator option

Multifunction generator option

- VOR/ILS signal generator for tests on VOR/ILS receivers
 - phase resolution 0.01°
 - DDM resolution 0.0001
- Stereo signal generator for measurements on FM broadcast transmitters and radio receivers
 - stereo separation >50 dB
 - unweighted S/N ratio >76 dB

Pulse generator option

- Single, delayed, double pulses
- Pulse width 20 ns to 1 s

Pulse modulator option

- Ideal for radar applications
- Rise/fall time <10 ns
- On/off ratio >80 dB
- Pulse frequencies up to 10 MHz

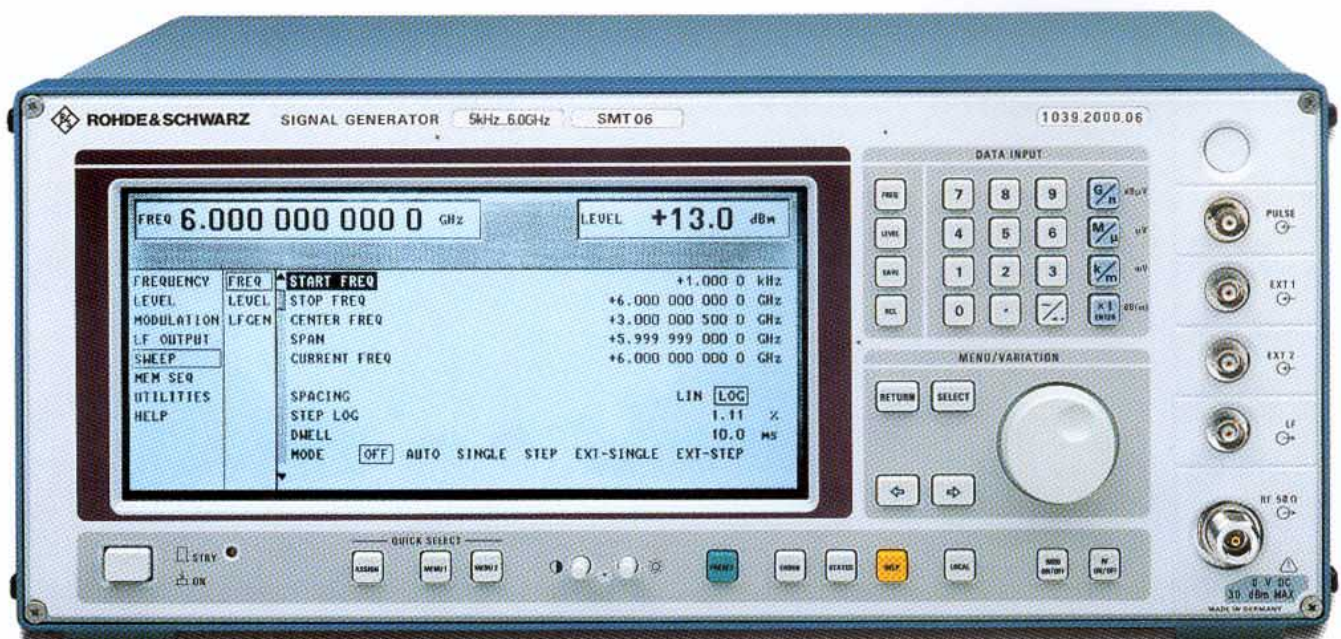



The ideal EMS signal source

With a specified lower frequency limit of 5 kHz (underrange down to 1 kHz), the SMT fully covers the frequency range for EMS measurements stipulated by IEC 801.

The digital, step-by-step sweep function with preselectable start and stop frequency, span, step width and step time enables the convenient testing of wide frequency ranges. The sweep function can also be used for the RF level and AF frequency.

The frequency response of cables, amplifiers, TEM cells, etc can be compensated already in the signal generator by means of a level correction function. Complicated external level controls or test routines are superfluous.

Excellent RF characteristics at a reasonable price

For high-accuracy measurements on AM, FM and SSB receivers, the signal source must be superior to the DUT. The low residual FM and SSB phase noise of the SMT make it suitable for in-channel and blocking measurements even on high-end receivers. The small level error of <1 dB in the frequency range ≤ 1.5 GHz allows high-precision sensitivity measurements.

Minimum RF emissions – for sensitive DUTs

Measurements on highly sensitive receivers such as pagers not only require high signal quality but also extremely high RF shielding of the signal source. Elaborate shielding measures keep RF emissions of the SMT to a minimum, ie $<0.1 \mu\text{V}$, induced in a two-turn loop 25 mm in diameter in the immediate vicinity of the instrument.



Characteristics and features

High-grade modulation characteristics

A wealth of modulation modes, the user-selectable combination of various types of modulation and a multitude of modulation sources make the SMT a highly flexible instrument for use in development, production and repair of radio equipment.

AM

The modulation frequency range is DC to 100 kHz. Among the outstanding AM characteristics of the SMT are its extremely low distortion and flat frequency and phase response – characteristics that play a particularly important role in measurements on VOR/ILS receivers, for example.

Broadband FM

The modulation frequency range is DC to 8 MHz. Maximum deviation is 40 MHz (at 6 GHz carrier frequency). In the FM DC mode, high carrier frequency accuracy is ensured through the use of a special control circuit. There is virtually no drift. The SMT can thus generate highly accurate FSK signals as required for tests on radiopagers. The use of an external Gaussian filter permits GFSK signals in line with the DECT standard to be generated.

Broadband ϕ M

Phase modulation ranges from DC to 2 MHz. This wide span opens up fields of application for which most signal generators do not qualify, for instance tests on phase-sensitive circuits or the generation of PSK modulation with freely selectable phase deviation up to 20 rad.

Pulse modulation (option)

Its high-quality pulse modulation, featuring an on/off ratio better than 80 dB and a rise/fall time shorter than 10 ns, make the SMT an ideal choice for radar applications. The pulse generator option allows pulsed signals to be produced independent of an external source.

Memory sequence function for automatic measurements

For frequently repeated measurement series, eg frequency response measurements or sequences of different types of single measurements, the memory sequence function affords a convenience otherwise obtained only by means of processor control. Up to 50 instrument settings can be stored in a non-volatile memory. After programming the sequence of measurements and the step time in a list, the automatic test run can be started.

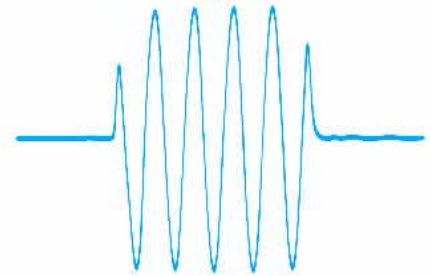

Pulse modulation of 50-MHz carrier

A wealth of functions – yet easy to operate

As a rule, the more functions provided in a unit, the more complex the operation. This certainly applies to conventional signal generators with multi-function keys and a variety of special functions.

But not with the SMT: operation is extremely easy thanks to a well thought-out operating concept featuring a large LCD display and menu guidance. All parameters selectable for a specific function are arranged in hierarchical order in a single display. Help texts for the individual functions mean that it is often unnecessary to consult a manual.

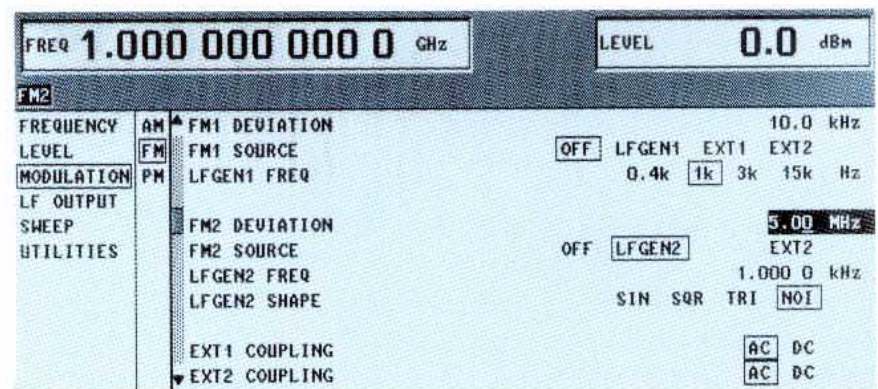

The FM modulation menu shows the clear-cut representation of selectable parameters and current instrument status on the display. Each setting can be made quickly and easily by means of the spinwheel and a few keys

Configurable to user's requirements

AM, FM, ϕ M and pulse modulation can be used with various internal and external modulation sources. The SMT can be tailored to suit specific applications by means of optional modules. These can also be retrofitted quickly and easily at a later date.

The **LF generator**, which can be fitted in addition to the fixed-frequency LF generator provided as standard, is a synthesizer up to 500 kHz. Besides sinewave, squarewave and triangular signals, it also supplies a noise signal. If two optional LF generators are fitted in a unit, multitone signals can be generated internally.

The **multifunction generator** with a frequency range from DC to 1 MHz produces the same signals as the optional LF generator and, in addition, **stereo** multiplex and **VOR/ILS** modulation signals. The multifunction generator option makes the SMT suitable even for highly demanding measurements on FM stereo and navigation receivers.

The **pulse generator** provides single and double pulses as required for radar receiver testing. The pulse repetition period (PP), pulse width (PW) and pulse delay (PD) (see diagram) can be set with high accuracy and resolution.

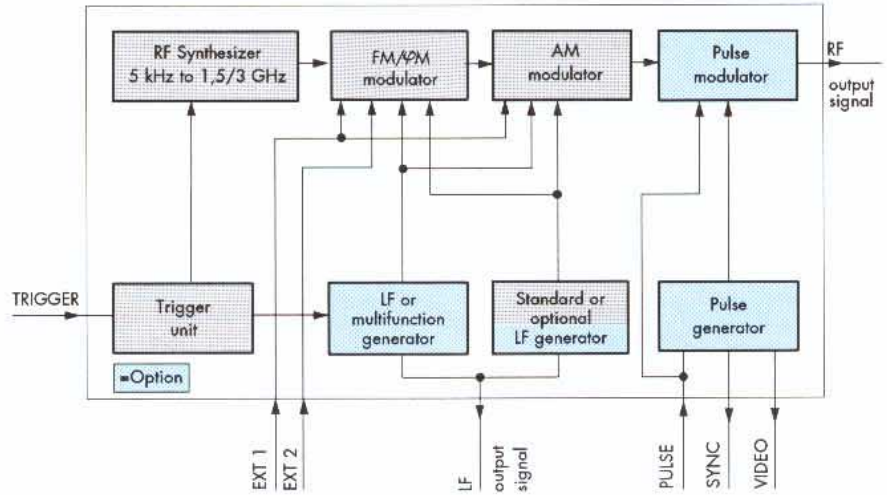

The multifunction generator also supplies VOR/ILS signals for tests on navigation receivers

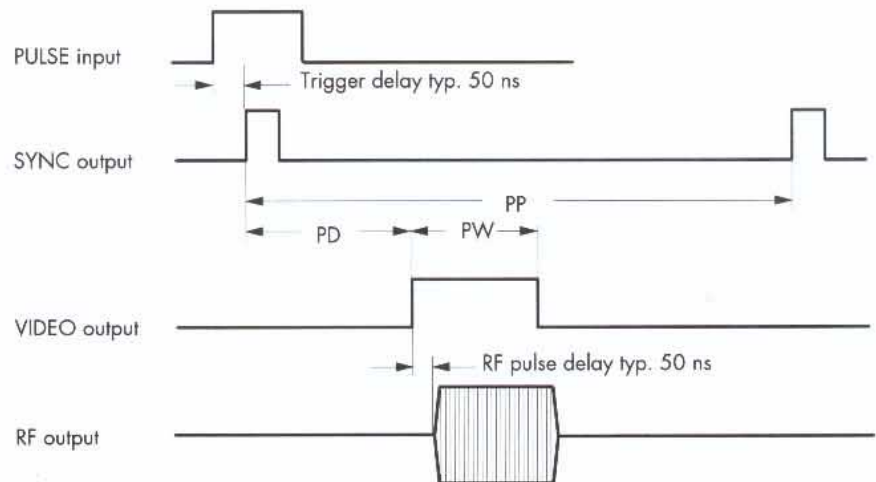

Specifications

Frequency

Range 5 kHz to 1.5 GHz (SMT02)
5 kHz to 3 GHz (SMT03)
5 kHz to 6 GHz (SMT06)

Underrange (specs not binding) down to 1 kHz
Resolution 0.1 Hz

Setting time after IEC/IEEE-bus delimiter to within $<1 \times 10^{-7}$ for $f > 67.5$ MHz and <70 Hz for $f < 67.5$ MHz

Phase offset <20 ms adjustable in steps of 1°

Reference frequency

Aging (after 30 days of operation) 1×10^{-6} /year
Temperature effect (0 to 55 °C) 2×10^{-6}

Standard $<1 \times 10^{-9}$ /year
Option SM-B1 $<1 \times 10^{-9}$ /day
 $<5 \times 10^{-8}$
10 min

Warm-up time —

Output for internal reference

Frequency 10 MHz
Level (EMF, sinewave) $1 V_{\text{rms}}$
Source impedance 50Ω

Input for external reference

Frequency 5 or 10 MHz
Permissible frequency error 3×10^{-6}
Input level 0.1 to $2 V_{\text{rms}}$

Input impedance 200Ω

Electronic tuning (TUNE)

Input voltage range 1×10^{-7} /V
Input impedance $\pm 10 V$
 $10 k\Omega$

Spectral purity

Spurious signals

Harmonics

level ≤ 10 dBm 1) <-30 dBc
level without overrange <-26 dBc

Subharmonics

$f < 1.5$ GHz none
 $f > 1.5$ GHz <-40 dBc
 $f > 3$ GHz <-34 dBc

Nonharmonics at >10 kHz

from carrier

$f < 1.5$ GHz <-80 dBc
 $f > 1.5$ GHz <-74 dBc
 $f > 3$ GHz <-68 dBc

Broadband noise for CW 1)

at >10 MHz from carrier,

1-Hz bandwidth

$f \leq 3$ GHz <-140 dBc (typ. <-145 dBc)
 $f > 3$ GHz <-134 dBc (typ. <-139 dBc)

SSB phase noise 20 kHz from carrier at

1-Hz bandwidth, FM/ϕM deviation

$<1\%$ of maximum deviation

<67.5 MHz <-120 dBc
80 MHz <-139 dBc
125 MHz <-134 dBc
250 MHz <-128 dBc
500 MHz <-122 dBc
1000 MHz <-116 dBc
2000 MHz <-110 dBc
3000 MHz <-109 dBc
6000 MHz <-103 dBc

Residual FM, rms,

at carrier frequency
 <67.5 MHz <4 Hz
67.5 to 187.5 MHz <1 Hz
187.5 to 375 MHz <2 Hz
375 to 750 MHz <4 Hz
750 to 1500 MHz <8 Hz
1500 to 3000 MHz <16 Hz
3000 to 6000 MHz <32 Hz

0.3 to 3 kHz (CCITT) **0.03 to 20 kHz**

<4 Hz <10 Hz
 <1 Hz <3 Hz
 <2 Hz <5 Hz
 <4 Hz <10 Hz
 <8 Hz <20 Hz
 <16 Hz <40 Hz
 <32 Hz <80 Hz

Residual AM, rms (0.03 to 20 kHz) 1) $<0.02\%$

Level

Range -144 to $+13$ dBm

Overrange

(specs not binding) up to 16 dBm

Resolution

0.1 dB

Total error for levels >-127 dBm 1)

$f < 1.5$ GHz <1 dB

$f > 1.5$ GHz <1.5 dB

$f > 3$ GHz <2 dB

Level flatness at 0 dBm 1)

$f \leq 3$ GHz <1 dB

$f > 3$ GHz <1.5 dB

Output impedance 50Ω

VSWR 1)	$f \leq 3$ GHz	$3 \text{ GHz} < f \leq 5 \text{ GHz}$	$f > 5 \text{ GHz}$
Level >0 dBm	<2	<2	<2
Level >0 dBm and option SM-B9 fitted (SMT06)	<2	<2	<2.5
Level ≤ 0 dBm	<1.5	<2	<2

Setting time (IEC/IEEE bus)

<25 ms (<10 ms with electronic level setting)

Non-interrupting level setting

(ATTENUATOR MODE FIXED)

Setting range 23 dB

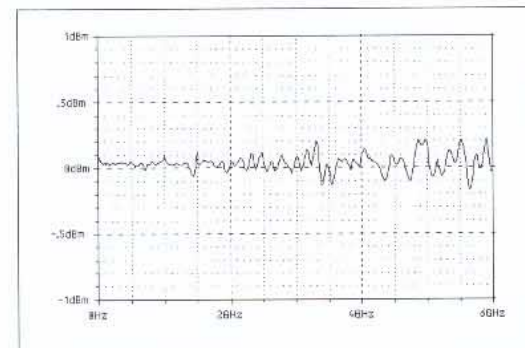

Typical level frequency response at 0 dBm

Overvoltage protection

protects the unit from externally applied RF power (50-Ω source) and DC voltages

Max. RF power

50 W (SMT02/03)

1 W (SMT06)

Max. DC voltage

35 V (SMT02/03)

0 V (SMT06)

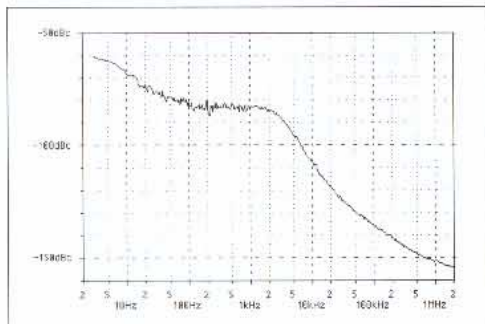

Typical SSB phase noise at 1 GHz (CW)

Simultaneous modulation	any combination of AM, FM (φ M) and pulse modulation	EXT1, EXT2 modulation inputs Input impedance Input voltage for selected deviation, AF= 10 Hz to 100 kHz	>100 k Ω 1 V _P (high/low indication for inaccuracy >3%)
Amplitude modulation	internal, external AC/DC	Pulse modulation	with option SM-B3, SM-B8 or SM-B9 external; internal with Pulse Generator SM-B4
Operating modes	0 to 100%	Operating modes	50 MHz to 1.5 GHz (SM-B3) 50 MHz to 3.0 GHz (SM-B8) 50 MHz to 6.0 GHz (SM-B9)
Modulation depth	modulation depths meeting AM specifications linearly decrease on increasing the level from 7 to 13 dBm; a status message will be output if the modulation depth is too great	Frequency range	10 dBm (SM-B3) 9 dBm (SM-B8) 8 dBm (SM-B9)
Resolution	0.1%	Max. output level	<-30 dBc for levels \leq 5 dBm
Setting error at 1 kHz ($m < 80\%$) ¹⁾	<4% of reading \pm 1%	Harmonics	>80 dB
AM distortion at 1 kHz ¹⁾		On/off ratio	<10 ns
m=30%	<1%	Rise/fall time (10/90%)	0 to 10 MHz
m=80%	<2%	Pulse repetition rate	typ. 50 ns
Modulation frequency range	DC to 100 kHz	Pulse delay	<-30 dBc
Modulation frequ. response ($m=60\%$) ¹⁾	<1 dB	Video feedthrough	
20 Hz (DC) to 50 kHz		PULSE modulation input	
Incidental φ M with 30% AM, AF = 1 kHz	<0.2 rad ($f \leq$ 3 GHz) <2 rad ($f >$ 3 GHz)	Input level	TTL (HCT)
EXT 1 modulation input		Input impedance	50 Ω or 10 k Ω
Input impedance	>100 k Ω		
Input voltage for selected modulation depth	1 V _P (high/low indication for inaccuracy >3%)	Internal modulation generator	
		Frequency	0.4/1/3/15 kHz \pm 3%
		Open-circuit voltage	1 V _P \pm 1% ($R_{out} = 10 \Omega$, $R_L > 200 \Omega$)
Frequency modulation	internal, external AC/DC, two tone with two separate channels FM1 and FM2	LF generator	option SM-B2
Operating modes		Waveforms	sinewave, triangular, squarewave, noise
Max. deviation at carrier frequency		Frequency range	0.1 Hz to 500 kHz
<130 MHz	5 MHz	sinewave, noise	0.1 Hz to 50 kHz
130 to 187.5 MHz	1.25 MHz	triangular, squarewave	0.1 Hz
187.5 to 375 MHz	2.5 MHz	Resolution	<1 $\times 10^{-4}$
375 to 750 MHz	5 MHz	Frequency error	<0.3 dB
750 to 1500 MHz	10 MHz	Frequency response (sinewave)	<0.5 dB
1500 to 3000 MHz	20 MHz	up to 100 kHz	<0.1% (level >0.5 V)
3000 to 6000 MHz	40 MHz	up to 500 kHz	1 mV _P to 4 V _P ($R_{out} = 10 \Omega$, $R_L > 200 \Omega$)
Resolution	<1%, min. 10 Hz	Distortion (20 Hz to 100 kHz)	Resolution
Setting error at AF=1 kHz (FM AC)	<3% of reading + 20 Hz	Open-circuit voltage	1% + 1 mV
FM distortion at AF=1 kHz and 10% max. deviation	<0.3%, typ. 0.1%	Resolution	<10 ms (after receipt of last character from IEC/IEEE bus)
Modulation frequency range, FM1	DC to 100 kHz	Setting error at 1 kHz (sinewave)	
FM2	DC to 8 MHz	Frequency setting time	
Modulation frequency response		Multifunction generator	option SM-B6
20 Hz (DC) to 100 kHz	<0.5 dB	Waveforms	sinewave, triangular, sawtooth, squarewave, noise, stereo MPX signals, VOR/ILS modulation signals
Incidental AM at AF=1 kHz, f > 1 MHz, deviation = 40 kHz	<0.1%	Frequency range	0.1 Hz to 1 MHz
Stereo modulation at		sinewave, noise	0.1 Hz to 50 kHz
40 kHz deviation, AF=1 kHz, RF= 88 to 108 MHz		triangular, sawtooth, squarewave	
Stereo separation	>50 dB ²⁾	Resolution	0.1 Hz
Unweighted S/N ratio (rms)	>76 dB	Frequency error	same as for reference frequency
Weighted S/N ratio (rms)	>70 dB	Frequency response (sinewave)	
Distortion	<0.2%	up to 100 kHz	<0.3 dB
Carrier frequency offset with FM DC ²⁾	<0.1% of deviation	up to 1 MHz	<0.5 dB
EXT1, EXT2 modulation inputs		Distortion (20 Hz to 100 kHz)	<0.1% (level >0.5 V)
Input impedance	>100 k Ω	Open-circuit voltage	1 mV _P to 4 V _P ($R_{out} = 10 \Omega$, $R_L > 200 \Omega$)
Input voltage for selected deviation, AF = 10 Hz to 100 kHz	1 V _P (high/low indication for inaccuracy >3%)	Resolution	1 mV
		Setting error at 1 kHz	1% + 1 mV
		Frequency setting time	<10 ms (after receipt of last character from IEC/IEEE bus)
Phase modulation	internal, external AC/DC, two tone with two separate modulation channels φ M1 and φ M2	Stereo multiplex signal	with multifunction generator
Operating modes		Stereo operating modes	R, L, R=L, R=-L, ARI (pilot tone/MPX signal can be connected to LF socket)
Max. deviation (broadband φ M only with φ M2)	Narrowb. φM, bandw. 100 kHz	Frequency range of L, R signal	0.1 Hz to 15 kHz
<130 MHz	50 rad	Preemphasis	50 μ s, 75 μ s
130 to 187.5 MHz	12.5 rad	Pilot-tone frequency	19 kHz \pm 1 Hz
187.5 to 375 MHz	25 rad	Pilot-tone phase	0 to 360°
375 to 750 MHz	50 rad	Resolution	0.1°
750 to 1500 MHz	100 rad	Stereo separation	>60 dB
1500 to 3000 MHz	200 rad	Distortion	<0.1% (L, R= 1 kHz)
3000 to 6000 MHz	400 rad	Carrier suppression (38 kHz)	>65 dB
Resolution	<1%, min. 0.001 rad	Settings selectable for ARI ³⁾	
Setting error at AF=1 kHz	<[3% of reading + 0.01 rad]	(ARI = broadcast information for motorists)	
Distortion at AF=1 kHz and max. deviation	<0.5%, typ. 0.1%	Area identification	A, B, C, D, E, F
Modulation frequency range, φ M1	DC to 100 kHz	Traffic announcement identification	on/off
φ M2	DC to 2 MHz	Additional signals (RDS, RDS+ARI)	application via EXT 1 input

VOR modulation signal¹⁾ Settings	with multifunction generator 30 Hz (VAR, REF)/9.96-kHz FM carrier, FM deviation, COM/ID tone 0 to 360° 0.01°
Phase	0 to 360°
Phase resolution	0.01°
Bearing error (RF output, 108 to 118 MHz)	<0.05°
FM error (deviation 480 Hz)	<1 Hz
ILS modulation signal¹⁾ Settings	with multifunction generator 90-Hz, 150-Hz tone, COM/ID tone, marker beacon 0 to ±0.8 0.0001
DDM setting range	0 to ±0.8
DDM resolution	0.0001
DDM error (RF output) Localizer (108 to 112 MHz) Glideslope (329 to 335 MHz)	<0.0004 + 2% of DDM reading <0.0008 + 2% of DDM reading
Pulse generator Operating modes	option SM-B4 single pulse, delayed pulse, double pulse
Active trigger edge	positive or negative
Pulse repetition period	100 ns to 85 s
Resolution	5-digit, min. 20 ns
Accuracy	same as for reference frequency
Pulse width	20 ns to 1 s
Resolution	4-digit, min. 20 ns
Accuracy	5% of reading ±5 ns
Pulse delay	40 ns to 1 s
Resolution	4-digit, min. 20 ns
Accuracy	5% of reading -10 to +20 ns
Double pulse	60 ns to 1 s
Resolution	4-digit, min. 20 ns
Accuracy	5% of reading -10 to +20 ns
Trigger delay	typ. 50 ns
PULSE modulation input	
Input level	TTL (HCT)
Input impedance	50 Ω or 10 kΩ
Sync output	TTL level (HC), 40 ns pulse width
Video output	TTL level (HC)
Sweep RF sweep, LF sweep Operating modes	digital, in discrete steps LF sweep with option SM-B2 automatic, single-shot, manual or externally triggered, linear or logarithmic
Sweep range and step width (lin)	freely selectable
step width (log)	0.01 to 100%
Level sweep Operating modes	automatic, single-shot, manual or externally triggered, logarithmic
Sweep range	0.1 to 20 dB
Step width	0.1 to 20 dB
Step time	10 ms to 5 s
Resolution	0.1 ms
Markers	3, freely selectable
MARKER output signal	TTL/HC logic signal, selectable polarity 0 to 10 V
X output BLANK output signal	TTL/HC logic signal, selectable polarity
Memory for instrument settings Storable settings	50
Memory sequence modes	automatic, single-shot, manual or externally triggered
Step time	50 ms to 60 s
Resolution	1 ms
Remote control System	IEC 625 (IEEE 488)
Instruction set	SCPI 1993.0
Connector	24-contact Amphenol
IEC/IEEE-bus address	0 to 30
Interface functions	SH1, AH1, T6, L4, SR1, RL1, PP1, DC1, DT1, C0

¹⁾ Does not apply to non-interrupting level setting
(ATTENUATOR MODE FIXED and USER CORR).

²⁾ Applies to a period of one hour after calibration and with temperature
variations <5°C.

³⁾ In the ARI mode, L = R = OFF.

General data

Power supply	90 to 132 V (AC), 47 to 440 Hz, 180 to 265 V (AC), 47 to 440 Hz, autosetting to AC voltage, max. 300 VA, safety class I VDE 0411 (IEC 348)
Electromagnetic compatibility Standards met	German Postal Decree 243/1991, EN 55011 (VDE 0875 T11), class B, VDE 0875, interference suppression level K, MIL-STD 461 B – RE 02 radiated emissions – CE 03 conducted emissions – CS 01/02 conducted susceptibility
RF emissions (f < 1 GHz)	<0.1 μV (induced in a two-turn loop 25 mm in dia at a distance of 25 mm from any surface of the enclosure) 10 V/m
Radiated susceptibility	10 V/m
Ambient conditions Operating temperature range	0 to 55 °C ⁴⁾
Storage temperature range	-40 to +70 °C
Humidity	DIN IEC 68-2-30, +40 °C
Mechanical stress Shock	to MIL-STD 810 D, 40 g shock spectrum to DIN IEC 68-2-6, 5 to 55 Hz 10 m/s ² rms, 10 to 300 Hz
Vibration, sinewave	
Vibration, noise	
Dimensions (W x H x D)	435 mm x 192 mm x 350 mm
Weight	20 kg for fully equipped unit

Ordering information

Order designations	Signal Generator SMT02 1039.2000.02 Signal Generator SMT03 1039.2000.03 Signal Generator SMT06 1039.2000.06	
Accessories supplied	power cable, operating manual	
Options		
Reference Oscillator OXCO	SM-B1	1036.7599.02
LF Generator ⁵⁾	SM-B2	1036.7947.02
Pulse Modulator for SMT02 ⁵⁾⁶⁾	SM-B3	1036.6340.02
Pulse Modulator for SMT03 ⁵⁾⁶⁾	SM-B8	1036.6805.02
Pulse Modulator for SMT06 ⁵⁾⁶⁾	SM-B9	1039.5100.02
Pulse Generator (only with option SM-B3 or SM-B8/SM-B9)	SM-B4	1036.9310.02
Multifunction Generator ⁵⁾	SM-B6	1036.7760.02
Rear Connectors for RF and AF	SMT-B19	1039.4003.02
Recommended extras		
19" Rack Adapter	ZZA-94	0396.4905.00
Service Kit	SM-Z2	1039.3520.02
SMT Service Manual		1039.3359.24



⁴⁾ Contrast of LCD display degraded at high temperatures.

⁵⁾ A second optional modulation generator (SM-B2 or SM-B6) can be fitted
only if no pulse modulator (SM-B3, SM-B8 or SM-B9) is fitted.

⁶⁾ Retrofit by authorized service centers only.

Minimum maintenance requirements

Calibration

Calibration of the unit is required every three years at the earliest. Calibration values are loaded via the RS-232-C or IEC/IEEE-bus interface to ensure frequency and level accuracy to specifications. The unit neither needs to be opened, nor are any mechanical adjustments to be made.

Self-diagnostics

For maintenance and calibration, precise data on the instrument status are needed. Using the built-in test equipment, the SMT supplies these data without any extra equipment required.

Self-test for enhanced reliability

The signal generator status is continuously monitored. The SMT indicates malfunctions and deviations from nominal values by means of a message on the display.

Built-in test equipment

The signal generator can be fully checked without any extra test equipment required and without opening the unit. There are 65 test points covering all crucial areas in signal generation such as RF signal levels and control circuit monitoring voltages. When a test point is called up via the keyboard or the IEC/IEEE bus, its number and value appear on the display. The source of error can thus easily be identified in the event of a malfunction.

A diagnostic and adjustment program for process controllers compatible with the industry standard (included in Service Kit SM-Z2) enables the automatic evaluation and logging of the instrument status. Adjustments can easily and rapidly be made without any extra test equipment required. During the several days of burn-in following production, the SMT is continuously checked through with the aid of this program. This ensures that an extremely reliable instrument tested throughout the entire temperature range will be supplied to the customer.

Rear panel of SMT

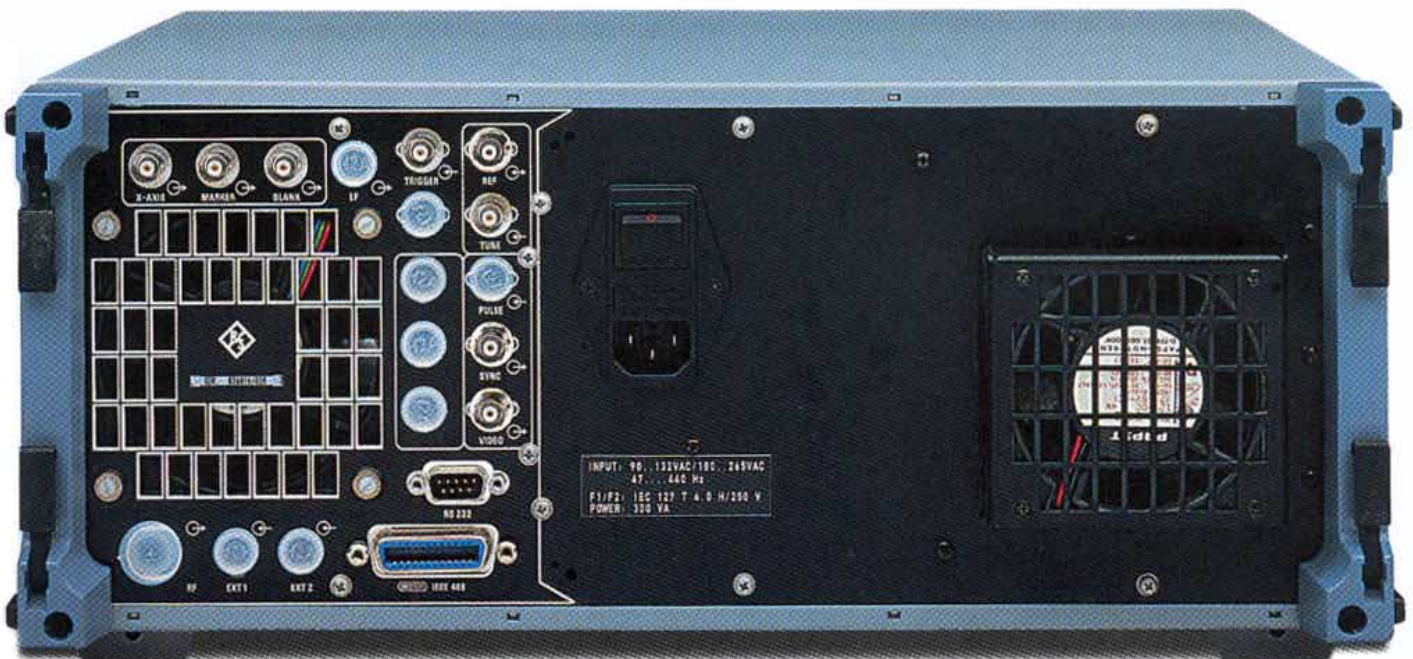



ROHDE & SCHWARZ

ROHDE & SCHWARZ GmbH & Co. KG · Mühlendorfstrasse 15 · D-81671 München
P.O.B. 8014 69 · D-81614 München · Telephone +4989 4129-0 · Fax +4989 4129-3567